

Fundamentals of Manual Metal Arc (MMA) Welding

Welding Technique

Successful MMA welding depends on the following factors:

- 1 Selection of the correct electrode
- 2 Selection of the correct size of the electrode for the job
- 3 Correct welding current
- 4 Correct arc length
- 5 Correct angle of electrode to work
- 6 Correct travel speed
- 7 Correct preparation of work to be welded.

Electrode Selection

As a general rule, the selection of an electrode is straight forward, in that it is only a matter of selecting an electrode of similar composition to the parent metal. However, for some metals there is a choice of several electrodes, each of which has particular properties to suit specific classes of work. Often, one electrode in the group will be more suitable for general applications due to its all round qualities.

The table below shows just a few of the wide range of electrodes available from BOC, with their typical areas of application.

For example, the average welder will carry out most fabrication using mild steel and for this material has a choice of various standard BOC electrodes, each of which will have qualities suited to particular tasks. For general mild steel work, however, BOC Smootharc 13 electrodes will handle virtually all applications. BOC Smootharc 13 is suitable for welding mild steel in all positions using AC or DC power sources. Its easy striking characteristics and the tolerance it has for work where fit-up and plate surfaces are not considered good, make it the most attractive electrode of its class. Continuous development and improvement of BOC Smootharc 13 have provided in-built operating qualities, which appeal to the beginner and experienced operator alike. For further advice on the selection of electrodes for specific applications, or to obtain a copy of the 'Welding Consumables: Selection Chart', contact your local BOC representative on 131 262.

Electrodes and Typical Applications

Name	AWS Classification	Application
BOC Smootharc 13	E6013	A premium quality electrode for general structural and sheet metal work in all positions, including vertical-down using low carbon steels
BOC Smootharc 24	E7024	An iron powder electrode for high speed welding for H-V fillets and flat butt joints. Medium to heavy structural applications in low carbon steels
BOC Smootharc 18	E7018-1	A premium quality, all positional hydrogen controlled electrode for carbon steels in pressure vessel applications and where high integrity welding is required; and for free-machining steels containing sulphur
BOC Smootharc S 308L	E308L	Rutile basic coated low carbon electrodes for welding austenitic stainless steel
BOC Smootharc S 316L	E316L	
BOC Smootharc S 309L	E309L	Rutile basic coated low carbon electrode for welding mild steel to stainless steel and difficult to weld material

Electrode Size

The size of the electrode generally depends on the thickness of the section being welded, and the thicker the section the larger the electrode required. In the case of light sheet, the electrode size used is generally slightly larger than the work being welded. This means that, if 2.0 mm sheet is being welded, 2.5 mm diameter electrode is the recommended size.

The following table gives the maximum size of electrodes that may be used for various thicknesses of section.

WARNING Welding can give rise to electric shock, excessive noise, eye and skin burns due to the arc rays, and a potential health hazard if you breathe in the emitted fumes and gases. Read all the manufacturer's instructions to achieve the correct welding conditions and ask your employer for the Materials Safety Data Sheets. Refer to www.boc.com.au or www.boc.co.nz

8 Fundamentals of Manual Metal Arc (MMA) Welding

Recommended Electrode Sizes

Average Thickness of Plate or Section	Maximum Recommended Electrode Diameter
1.5–2.0 mm	2.5 mm
2.0–5.0 mm	3.2 mm
5.0–8.0 mm	4.0 mm
≥8.0 mm	5.0 mm

Welding Current

Correct current selection for a particular job is an important factor in arc welding. With the current set too low, difficulty is experienced in striking and maintaining a stable arc. The electrode tends to stick to the work, penetration is poor and beads with a distinct rounded profile will be deposited.

Excessive current is accompanied by overheating of the electrode. It will cause undercut and burning through of the material, and will give excessive spatter. Normal current for a particular job may be considered as the maximum, which can be used without burning through the work, over-heating the electrode or producing a rough spattered surface (i.e. the current in the middle of the range specified on the electrode package is considered to be the optimum).

In the case, of welding machines with separate terminals for different size electrodes, ensure that the welding lead is connected to the correct terminal for the size electrode being used. When using machines with adjustable current, set on the current range specified. The limits of this range should not normally be exceeded. The following table shows the current ranges generally recommended for BOC Smootharc 13.

Generally Recommended Current Range for BOC Smootharc 13

Electrode Size (mm)	Current Range (Amp)
2.5	60–95
3.2	110–130
4.0	140–165
5.0	170–260

Arc Length

To strike the arc, the electrode should be gently scraped on the work until the arc is established. There is a simple rule for the proper arc length; it should be the shortest arc that gives a good surface to the weld. An arc too long reduces penetration, produces spatter and gives a rough surface finish to the weld. An excessively short arc will cause sticking of the electrode and rough deposits that are associated with slag inclusions.

For downhand welding, an arc length not greater than the diameter of the core wire will be most satisfactory. Overhead welding requires a very short arc, so that a minimum of metal will be lost. Certain BOC electrodes have been specially designed for 'touch' welding. These electrodes may be dragged along the work and a perfectly sound weld is produced.

Electrode Angle

The angle that the electrode makes with the work is important to ensure a smooth, even transfer of metal.

The recommended angles for use in the various welding positions are covered later.

Correct Travel Speed

The electrode should be moved along in the direction of the joint being welded at a speed that will give the size of run required. At the same time, the electrode is fed downwards to keep the correct arc length at all times. As a guide for general applications, the table below gives recommended run lengths for the downhand position.

Correct travel speed for normal welding applications varies between approximately 100 and 300 mm per minute, depending on electrode size, size of run required and the amperage used.

Excessive travel speeds lead to poor fusion, lack of penetration etc, while too slow a rate of travel will frequently lead to arc instability, slag inclusions and poor mechanical properties.

Run Length per Electrode – BOC Smootharc 13

Electrode Size (mm)	Electrode Length (mm)	Run Length (mm)	
		Minimum	Maximum
4.0	350	175	300
3.2	350	125	225
2.5	350	100	225

Correct Work Preparation

The method of preparation of components to be welded will depend on equipment available and relative costs. Methods may include sawing, punching, shearing, machining, flame cutting and others.

In all cases edges should be prepared for the joints that suit the application. The following section describes the various joint types and areas of application.

Types of Joints

Butt Welds

A butt weld is a weld made between two plates so as to give continuity of section.

Close attention must be paid to detail in a butt weld to ensure that the maximum strength of the weld is developed. Failure to properly prepare the edges may lead to the production of faulty welds, as correct manipulation of the electrode is impeded.

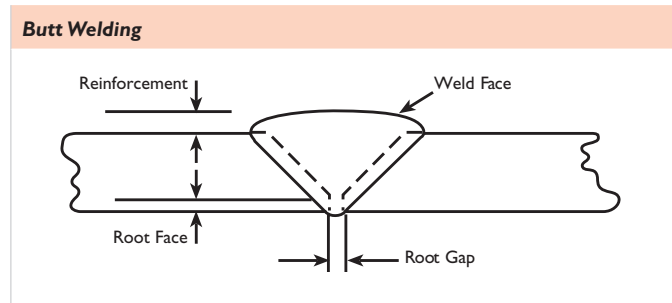







WARNING Welding can give rise to electric shock, excessive noise, eye and skin burns due to the arc rays, and a potential health hazard if you breathe in the emitted fumes and gases. Read all the manufacturer's instructions to achieve the correct welding conditions and ask your employer for the Materials Safety Data Sheets. Refer to www.boc.com.au or www.boc.co.nz

Two terms relating to the preparation of butt welds require explanation at this stage. They are:

- **Root Face:** the proportion of the prepared edge that has not been bevelled (Land).
- **Root Gap:** the separation between root faces of the parts to be joined.

Various types of butt welds are in common use and their suitability for different thickness of steel are described as follows:

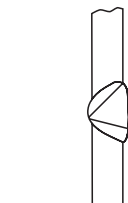
<p>Square Butt Weld</p> 	<p>The edges are not prepared, but are separated slightly to allow fusion through the full thickness of the steel. Suitable for plate up to 6 mm in thickness.</p>
<p>Single 'V' Butt Weld</p> 	<p>This is commonly used for plate up to 16 mm in thickness and on metal of greater thickness where access is available from only one side.</p>
<p>Double 'V' Butt Weld</p> 	<p>Used on plate of 12 mm and over in thickness when welding can be applied from both sides. It allows faster welding and greater economy of electrodes than a single 'V' preparation on the same thickness of steel and also has less tendency to distortion as weld contraction can be equalised.</p>
<p>Butt Weld with Backing Material</p> 	<p>When square butt welds or single 'V' welds cannot be welded from both sides, it is desirable to use a backing bar to ensure complete fusion.</p>
<p>Single 'U' Butt Weld</p> 	<p>Used on thick plates as an alternative to a single 'V' preparation. It has advantages in speed of welding. It takes less weld metal than a single 'V', there is less contraction and there is, therefore, a lessened tendency to distortion. Preparation is more expensive than in the case of a 'V', as machining is required. This type of joint is most suitable for material over 40 mm in thickness.</p>
<p>Double 'U' Butt Weld</p> 	<p>For use on thick plate that is accessible for welding from both sides. For a given thickness it is faster, needs less weld metal and causes less distortion than a single 'U' preparation.</p>
<p>Horizontal Butt Weld</p> 	<p>The lower member in this case is bevelled to approximately 15° and the upper member 45°, making an included angle of 60°. This preparation provides a ledge on the lower member, which tends to retain the molten metal.</p>

General Notes on Butt Welds

The first run in a prepared butt weld should be deposited with an electrode not larger than 4.0 mm. The angle of the electrode for the various runs in a butt weld is shown below.

It is necessary to maintain the root gap by tacking at intervals or by other means, as it will tend to close during welding.

All single 'V', single 'U' and square butt welds should have a backing run deposited on the underside of the joint, otherwise 50% may be deducted from the permissible working stress of the joint.

Before proceeding with a run on the underside of a weld, it is necessary to back-gouge or grind that side of the joint.

Butt welds should be overfilled to a certain extent by building up the weld until it is above the surface of the plate. Excessive reinforcement, however, should be avoided.

In multi-run butt welds, it is necessary to remove all slag and surplus weld metal before a start is made on additional runs. This is particularly important with the first run, which tends to form sharp corners that cannot be penetrated with subsequent runs. Electrodes larger than 4.0 mm are not generally used for vertical or overhead butt welds.

The diagrams below indicate the correct procedure for welding thick plate when using multiple runs.

Bead Sequence for 1st and 2nd Layers

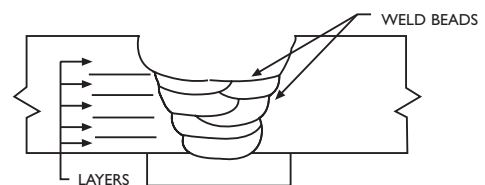

Bead Sequence for Subsequent Layers

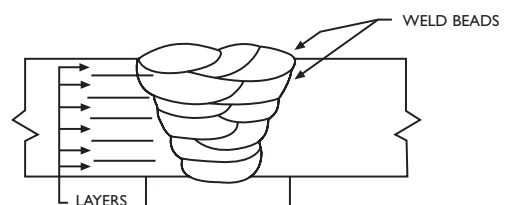

Welding Progression Angle

- 1 Weld Metal
- 2 Workpiece
- 3 Electrode
- 4 Slag
- 5 Welding Direction
- 6 70–85° Angle
- 7 Arc
- 8 Weld Pool

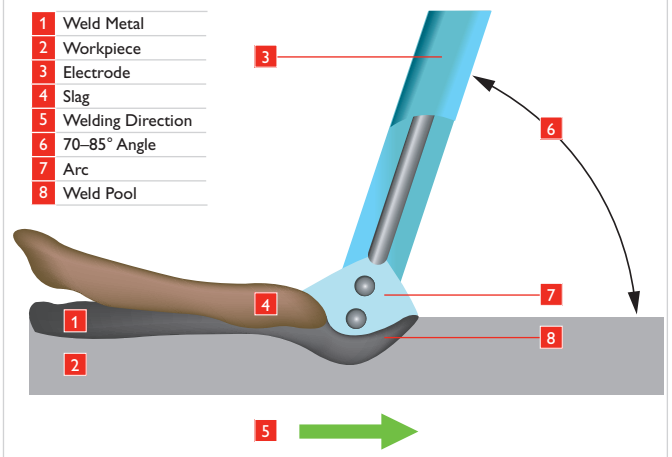

WARNING Welding can give rise to electric shock, excessive noise, eye and skin burns due to the arc rays, and a potential health hazard if you breathe in the emitted fumes and gases. Read all the manufacturer's instructions to achieve the correct welding conditions and ask your employer for the Materials Safety Data Sheets. Refer to www.boc.com.au or www.boc.co.nz

8 Fundamentals of Manual Metal Arc (MMA) Welding

Fillet Welds

A fillet weld is approximately triangular in section, joining two surfaces not in the same plane and forming a lap joint, tee joint or corner joint. Joints made with fillet welds do not require extensive edge preparation, as is the case with butt welded joints, since the weld does not necessarily penetrate the full thickness of either member. It is, however, important that the parts to be joined be clean, close fitting, and that all the edges on which welding is to be carried out are square. On sheared plate, it is advisable to entirely remove any 'false cut' on the edges prior to welding.

Fillet welds are used in the following types of joints:

'T' Joints

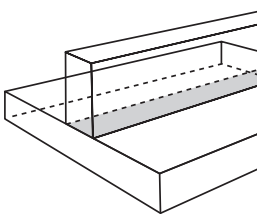

A fillet weld may be placed either on one or both sides, depending on the requirements of the work. The weld metal should fuse into or penetrate the corner formed between the two members. Where possible, the joint should be placed in such a position as to form a 'Natural 'V' fillet' since this is the easiest and fastest method of fillet welding.

Lap Joints

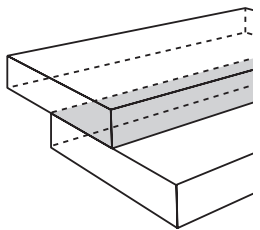

In this case, a fillet weld may be placed either on one or both sides of the joint, depending on accessibility and the requirements of the joint. However, lap joints, where only one weld is accessible, should be avoided where possible and must never constitute the joints of tanks or other fabrications where corrosion is likely to occur behind the lapped plates. In applying fillet welds to lapped joints, it is important that the amount of overlap of the plates be not less than five times the thickness of the thinner part. Where it is required to preserve the outside face or contour of a structure, one plate may be joggled.

Corner Joints

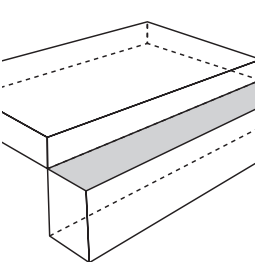

The members are fitted as shown, leaving a 'V'-shaped groove in which a fillet weld is deposited. Fusion should be complete for the full thickness of the metal. In practice, it is generally necessary to have a gap or a slight overlap on the corner. The use of a 1.0–2.5 mm gap has the advantage of assisting penetration at the root, although setting up is a problem. The provision of an overlap largely overcomes the problem of setting up, but prevents complete penetration at the root and should therefore be kept to a minimum (i.e. 1.0–2.5 mm).

The following terms and definitions are important in specifying and describing fillet welds.

Leg Length

A fusion face of a fillet weld, as shown below. In Australia and NZ, specifications for fillet weld sizes are based on leg length.

Throat Thickness

A measurement taken through the centre of a weld from the root to the face, along the line that bisects the angle formed by the members to be joined. Many countries use throat thickness rather than leg length.

Effective throat thickness is a measurement on which the strength of a weld is calculated. The effective throat thickness is based on a mitre fillet (Concave Fillet Weld), which has a throat thickness equal to 70% of the leg length. For example, in the case of a 20 mm fillet, the effective throat thickness will be 14 mm.

Convex Fillet Weld

A fillet weld in which the contour of the weld metal lies outside a straight line joining the toes of the weld. A convex fillet weld of specified leg length has a throat thickness in excess of the effective measurement.

Convex Fillet Weld

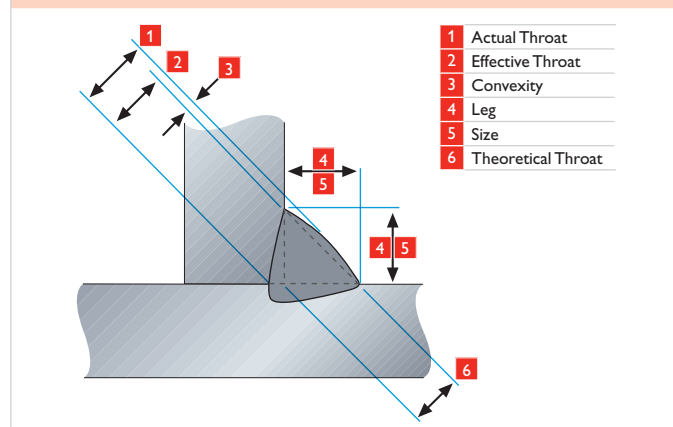

Concave Fillet Weld

A fillet in which the contour of the weld is below a straight line joining the toes of the weld. It should be noted that a concave fillet weld of a specified leg length has a throat thickness less than the effective throat thickness for that size fillet. This means that, when a concave fillet weld is used, the throat thickness must not be less than the effective measurement. This entails an increase in leg length beyond the specified measurement.

Concave Fillet Weld

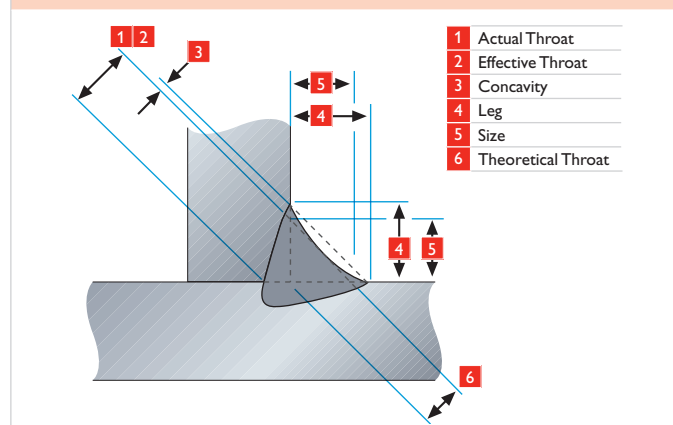

WARNING Welding can give rise to electric shock, excessive noise, eye and skin burns due to the arc rays, and a potential health hazard if you breathe in the emitted fumes and gases. Read all the manufacturer's instructions to achieve the correct welding conditions and ask your employer for the Materials Safety Data Sheets. Refer to www.boc.com.au or www.boc.co.nz

The size of a fillet weld is affected by the electrode size, welding speed or run length, welding current and electrode angle. Welding speed and run length have an important effect on the size and shape of the fillet, and on the tendency to undercut.

Insufficient speed causes the molten metal to pile up behind the arc and eventually to collapse. Conversely, excessive speed will produce a narrow irregular run having poor penetration, and where larger electrodes and high currents are used, undercut is likely to occur.

Fillet Weld Data

Nominal Fillet Size (mm)	Min. Throat Thickness (mm)	Plate Thickness (mm)	Electrode Size (mm)
5.0	3.5	5.0–6.3	3.2
6.3	4.5	6.3–12	4.0
8.0	5.5	8.0–12 and over	5.0
10.0	7.0	10 and over	4.0

Selection of welding current is important. If it is too high, the weld surface will be flattened and undercut accompanied by excessive spatter is likely to occur. Alternatively, a current which is too low will produce a rounded narrow bead with poor penetration at the root. The first run in the corner of a joint requires a suitably high current to achieve maximum penetration at the root. A short arc length is recommended for fillet welding. The maximum size fillet which should be attempted with one pass of a large electrode is 8.0 mm. Efforts to obtain larger leg lengths usually result in collapse of the metal at the vertical plate and serious undercutting. For large leg lengths, multiple run fillets are necessary. These are built up as shown below. The angle of the electrode for various runs in a downhand fillet weld is also shown.

Recommended Electrode Angles For Fillet Welds

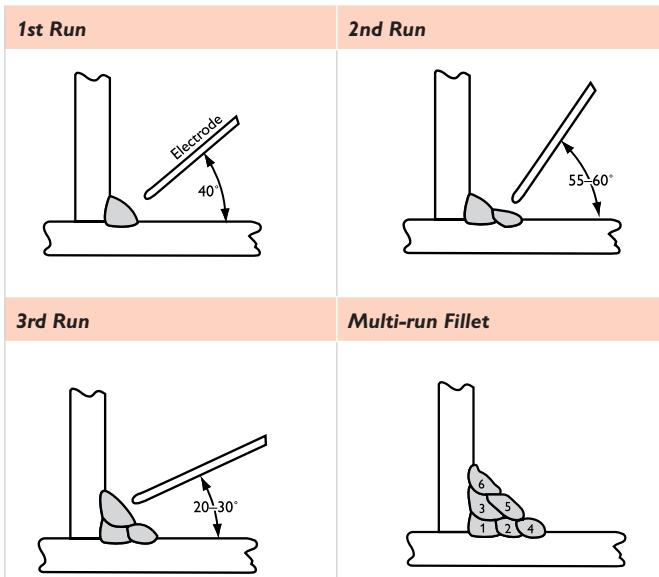

Multi-run (multi-pass) horizontal fillets have each run made using the same run lengths (Run Length per Electrode Table). Each run is made in the same direction, and care should be taken with the shape of each, so that it has equal leg lengths and the contour of the completed fillet weld is slightly convex with no hollows in the face.

Vertical fillet welds can be carried out using the upwards or downwards technique. The characteristics of each are: Upwards – current used is low, penetration is good, surface is slightly convex and irregular. For multiple run fillets, large single pass weaving runs can be used. Downwards – current used is medium, penetration is poor, each run is small, concave and smooth.

The downwards method should be used for making welds on thin material only. Electrodes larger than 4.0 mm are not recommended for vertical-down welding. All strength joints in vertical plates 10.0 mm thick or more should be welded using the upward technique. This method is used because of its good penetration and weld metal quality. The first run of a vertical-up fillet weld should be a straight sealing run made with 3.2 mm or 4.0 mm diameter electrode. Subsequent runs for large fillets may be either numerous straight runs or several wide weaving runs.

Correct selection of electrodes is important for vertical welding.

In overhead fillet welds, careful attention to technique is necessary to obtain a sound weld of good profile. Medium current is required for best results. High current will cause undercutting and bad shape of the weld, while low current will cause slag inclusions. To produce a weld having good penetration and of good profile, a short arc length is necessary. Angles of electrode for overhead fillets is illustrated below.

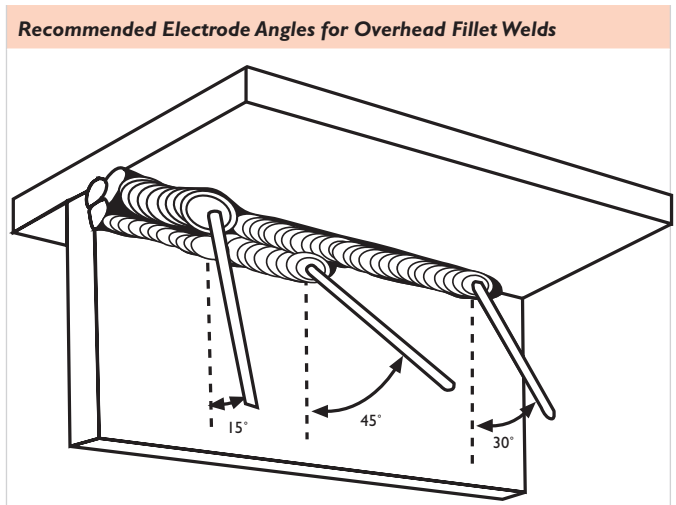

WARNING Welding can give rise to electric shock, excessive noise, eye and skin burns due to the arc rays, and a potential health hazard if you breathe in the emitted fumes and gases. Read all the manufacturer's instructions to achieve the correct welding conditions and ask your employer for the Materials Safety Data Sheets. Refer to www.boc.com.au or www.boc.co.nz

Welding Defects and Problems

Manual metal arc welding, like other welding processes, has welding procedure problems that may develop and which can cause defects in the weld. Some defects are caused by problems with the materials. Other welding problems may not be foreseeable and may require immediate corrective action. A poor welding technique and improper choice of welding parameters can cause weld defects.

Defects that can occur when using the shielded metal arc welding process are slag inclusions, wagon tracks, porosity, wormhole porosity, undercutting, lack of fusion, overlapping, burn through, arc strikes, craters and excessive weld spatter. Many of these welding technique problems weaken the weld and can cause cracking. Other problems that can occur and which can reduce the quality of the weld are arc blow, finger nailing and improper electrode coating moisture contents.

Defects Caused by Welding Technique

Slag Inclusions



Slag inclusions occur when slag particles are trapped inside the weld metal, which produces a weaker weld. These can be caused by:

- erratic travel speed
- too wide a weaving motion
- slag left on the previous weld pass
- too large an electrode being used
- letting slag run ahead of the arc.

This defect can be prevented by:

- a uniform travel speed
- a tighter weaving motion
- complete slag removal before welding
- using a smaller electrode
- keeping the slag behind the arc, which is done by shortening the arc, increasing the travel speed or changing the electrode angle.

Wagon Tracks

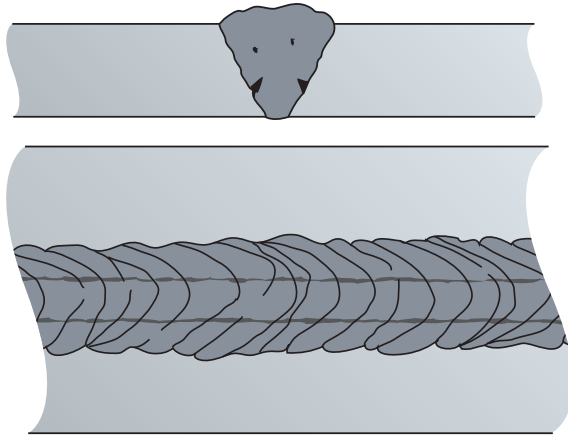

Top View Thru Transparent Bead

Wagon tracks are linear slag inclusions that run the longitudinal axis of the weld. They result from allowing the slag to run ahead of the weld puddle and by slag left on the previous weld pass. These occur at the toe lines of the previous weld bead.

Porosity



Porosity is gas pockets in the weld metal that may be scattered in small clusters or along the entire length of the weld. Porosity weakens the weld in approximately the same way that slag inclusions do.

Porosity may be caused by:

- excessive welding current
- rust, grease, oil or dirt on the surface of the base metal
- excessive moisture in the electrode coatings
- impurities in the base metal
- too short an arc length, except when using low-hydrogen or stainless steel electrodes
- travel speed too high, which causes freezing of the weld puddle before gases can escape.

This problem can be prevented by:

- lowering the welding current
- cleaning the surface of the base metal
- redrying electrodes
- changing to a different base metal with a different composition
- using a slightly longer arc length
- lowering the travel speed to let the gases escape
- preheating the base metal, using a different type of electrode, or both.

Wormhole Porosity (Piping Porosity)

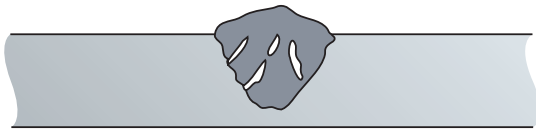

Wormhole porosity is the name given to elongated gas pockets. The best method of preventing this is to lower the travel speed to permit gases to escape before the weld metal freezes.

Undercutting



Undercutting is a groove melted in the base metal next to the toe or root of a weld that is not filled by the weld metal. Undercutting causes a weaker joint and it can cause cracking. This defect is caused by:

- excessive welding current
- too long an arc length
- excessive weaving speed
- excessive travel speed.

On vertical and horizontal welds, it can also be caused by too large an electrode size and incorrect electrode angles. This defect can be prevented by:

- choosing the proper welding current for the type and size of electrode and the welding position
- holding the arc as short as possible
- pausing at each side of the weld bead when a weaving technique is used
- using a travel speed slow enough so that the weld metal can completely fill all of the melted out areas of the base metal.

Lack of Fusion

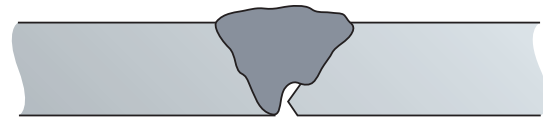

Lack of fusion is when the weld metal is not fused to the base metal. This can occur between the weld metal and the base metal or between passes in a multiple pass weld. Causes of this defect can be:

- excessive travel speed
- electrode size too large
- welding current too low
- poor joint preparation
- letting the weld metal get ahead of the arc.

Lack of fusion can usually be prevented by:

- reducing the travel speed
- using a smaller diameter electrode
- increasing the welding current
- better joint preparation
- using a proper electrode angle.

Overlapping

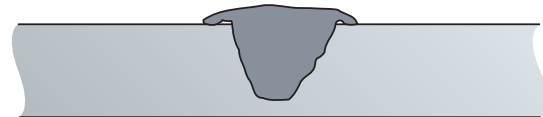

Overlapping is the protrusion of the weld metal over the edge or toe of the weld bead. This defect can cause an area of lack of fusion and create a notch, which can lead to crack initiation. Overlapping is often produced by:

- too slow a travel speed, which permits the weld puddle to get ahead of the electrode
- an incorrect electrode angle.

Legend to Welding Position Abbreviations

Symbol	Abbreviation	Description
	F	Flat
	H/V-FILLET	Horizontal-Vertical Fillet
	H	Horizontal
	V	Vertical
	V-DOWN	Vertical-Down
	OH	Overhead

WARNING Welding can give rise to electric shock, excessive noise, eye and skin burns due to the arc rays, and a potential health hazard if you breathe in the emitted fumes and gases. Read all the manufacturer's instructions to achieve the correct welding conditions and ask your employer for the Materials Safety Data Sheets. Refer to www.boc.com.au or www.boc.co.nz

Coating Types

It is the composition of the coating that differentiates one type of electrode from another and, to a degree, what type of application it can be used for. MMA electrodes, with a solid wire core, are generally categorised by the type of flux coating they employ. There are three main groups of electrode coating: rutile, basic and cellulosic, plus a less-widely-used acid type. The name of each group is a description of the main constituent of the coating. Although not strictly a coating type, iron-powder electrodes are often considered as a separate group.

Electrodes for cutting, grooving and gouging, plus those for hard-surfacing, including tubular MMA electrodes, are not classified by coating type.

Rutile Electrodes

Rutile electrodes have a coating that contains about 50% rutile sand (a pure form of titanium dioxide), plus additions of ferro-manganese, mineral carbonates and silicates, held together with approximately 15% sodium silicate, also known as waterglass. The rutile's characteristics include easy striking, stable arc, low spatter, good bead profile and, generally, easy slag removal from the electrode.

The electrode can operate on both AC and DC currents and can operate in all positions if the formulation of the coating is so designed.

One negative aspect of these electrodes is that they produce a high level of hydrogen, typically greater than 15ml/100g of deposited weld metal. This cannot be avoided, because they rely on a certain amount of moisture being present in the coating to operate properly. If the electrodes are dried too much, they will fail to function properly.

Rutile-coated electrodes are manufactured for welding mild and low-carbon steels. In this context, they are often referred to as general-purpose or GP electrodes. Some low-alloy grades also use rutile coatings. Rutile-type coatings, which are modifications of those used for ferritic steels, are also used on many austenitic stainless steel electrodes.

Basic Electrodes

Basic, or low-hydrogen, electrodes contain calcium carbonate and calcium fluoride in place of the rutile sand and mineral silicates. This makes them less easy to strike and more difficult to re-strike, due to the very deep cup formed at the tip during operation. They also have a poorer, more convex bead profile than rutile electrodes. The slag is more difficult to remove than the rutile types, but they do give better weld metal properties than rutile types, with a higher metallurgical quality.

Basic electrodes are capable of being used on AC or DC currents and can be used in multi-pass welds on materials of all thicknesses.

Basic electrodes do not rely on moisture to function properly, and for the more critical applications should be used completely dry. It is important to note that basic electrodes are only low-hydrogen electrodes if they have been correctly dried before use. This conventionally involves re-drying in ovens on site in accordance with manufacturers' recommendations. Drying can reduce weld metal hydrogen to less than 5ml/100g, as can vacuum-packing the electrodes. These can be used straight from the packs without any form of drying required. BOC Smootharc 16 and 18 electrodes are supplied in hermetically sealed containers, which ensures that they meet the H4 grade.

Basic-type electrodes for ferritic steels, with low-alloy additions to the coatings or the core wire, allow a much wider use, including sub-zero and elevated-temperature application. Basic coatings are also widely used for electrodes for welding stainless steels, nickel alloys, cast irons, copper and aluminium alloys, and for hard-facing applications.

Cellulosic Electrodes

Cellulosic electrodes contain a high proportion of organic material, replacing all or some of the rutile sand. This produces a fierce, deep penetrating arc and a faster burn-off rate. Cellulosic electrodes are more prone to spatter than rutile types. Only carbon and some low-alloy steels are made with a cellulosic coating and most run only on DC+ polarity, but some are made that will also operate on AC and DC-. They are truly all-positional electrodes in all sizes and even larger diameters up to 6 mm will operate vertical-down. Cellulosic electrodes are used for root passes and pipeline welding.

It should be noted that cellulosic electrodes generate high amounts of hydrogen. This presents a risk of hydrogen-induced cracking if correct welding procedures are not followed.

Acid Electrodes

Acid electrodes for mild steels have been largely replaced by rutile types, but some are still produced by a few manufacturers. These electrodes contain high amounts of iron oxide, are relatively easy to use and give a voluminous glassy slag that detaches easily. They are lower-strength products, so they are confined to use on non-structural components.

Acid-rutile electrodes for stainless steel are now replacing conventional rutile types. They are higher in silicon, which gives improved operating and wetting characteristics, and they are much more welder-friendly. They strike and re-strike readily and will operate on AC and DC current. They produce low spatter levels and an easily removed slag. However, they are prone to 'start porosity' and need re-drying before use to avoid this.

Iron-powder Electrodes

Iron-powder electrodes are often considered an independent group of consumables. As their name suggests, these electrodes contain high levels of iron powder held within the coating – as the coating melts, the iron powder creates more weld metal. This effectively improves the productivity from the electrode, allowing either larger or longer welds to be created from a single rod. The amount of iron powder added depends on the consumable being produced, but it is not uncommon for 75% of the core weight to be added.

The addition of the iron powder to the coating has the effect of increasing the overall diameter of the electrode and reducing the amount of fluxing agent present in the coating. With less fluxing agent available, the slag coating tends to be thinner, so many of the MMA electrode's positional welding characteristics are lost. This means that many of the electrodes can only be used in the flat or horizontal-vertical (H-V) positions.

Coatings for iron-powder electrodes may be based on either the rutile or basic systems.

Care and Conditioning of Consumables

Practical Considerations

Storage and Re-drying

MMA electrodes should be stored in dry, well-ventilated and preferably heated stores. For critical applications it is also recommended that they be held in temperature and humidity controlled conditions, maintaining humidity below 60%RH (Relative Humidity) and a temperature above the dew point to avoid moisture condensing onto the electrodes. Electrodes held in dry conditions will remain in prime condition for several years, but if the coating absorbs moisture, this will lead to a gradual deterioration. Evidence of deterioration includes the presence of white powdery areas on the surface of the coating, cracks in the coating or missing pieces of coating.

Electrodes with rutile or cellulosic coating require some moisture in the coating to operate properly and should not be re-dried. If rutile electrodes get wet, re-drying at about 80°C is all that is needed. Cellulosic electrodes must not be dried. In some hot environments they may need wetting to function efficiently.

Basic coated electrodes need to be dry to give low-hydrogen weld metal. Before use, these electrodes should be re-dried according to manufacturers' recommendations, put in holding ovens and then transferred to the workstations in heated quivers until needed. Vacuum-packed basic electrodes can be used straight from the packet.

Electrodes for non-ferrous alloys and stainless steel always need to be completely dry before use and should be treated in accordance with manufacturers' requirements.

Welding Parameters

Some electrodes will operate satisfactorily on AC or DC current and, for AC operation, manufacturers will recommend a minimum OCV (Open Circuit Voltage) to initiate a welding arc with the electrode.

WARNING Welding can give rise to electric shock, excessive noise, eye and skin burns due to the arc rays, and a potential health hazard if you breathe in the emitted fumes and gases. Read all the manufacturer's instructions to achieve the correct welding conditions and ask your employer for the Materials Safety Data Sheets. Refer to www.boc.com.au or www.boc.co.nz